

Installation information

METTLER TOLEDO
Weighing terminals IND4x9
Compact scales BBA4x9

METTLER TOLEDO

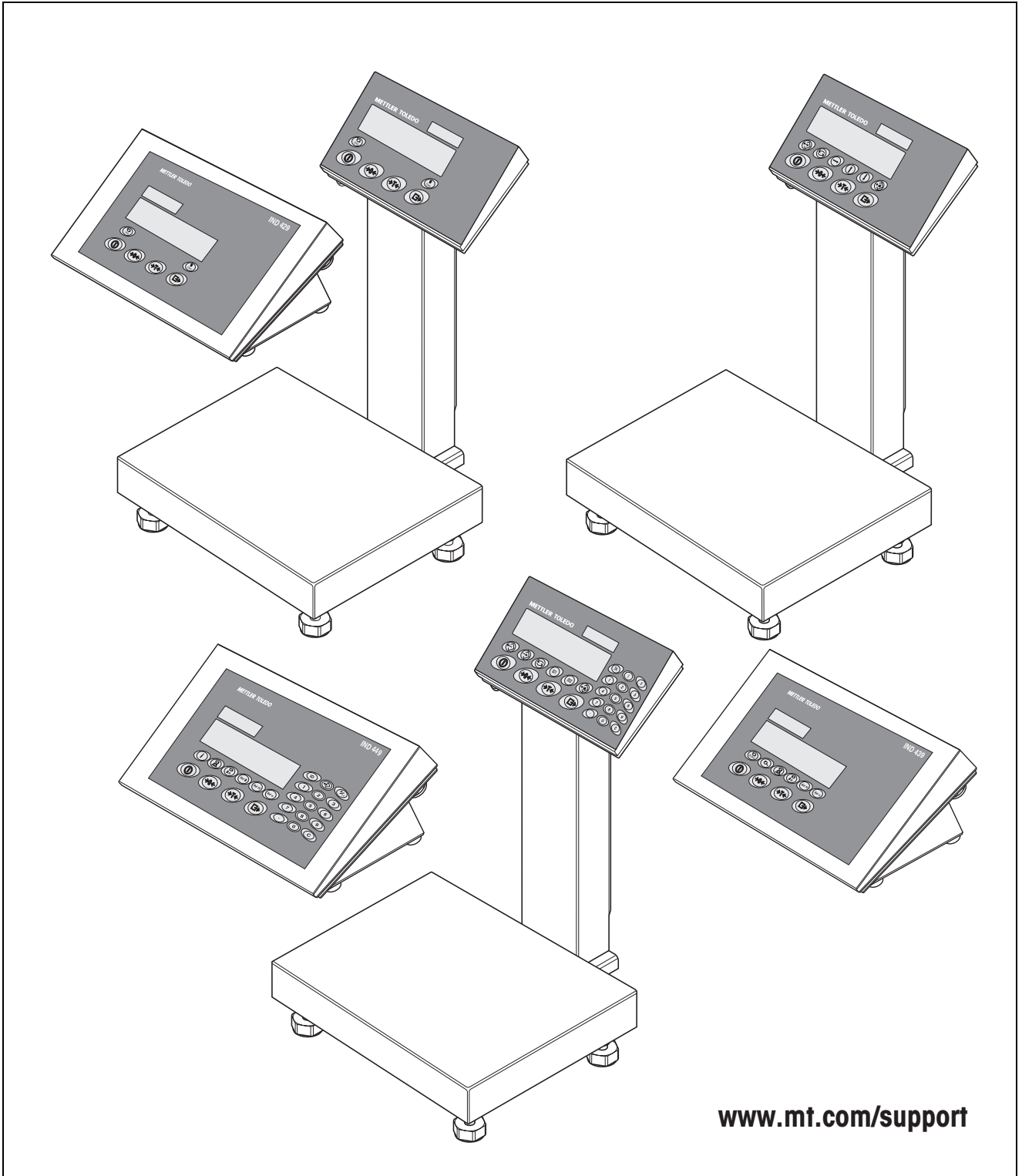

www.mt.com/support

ServiceXXL

Tailored Services

Congratulations on choosing the quality and precision of METTLER TOLEDO. Proper use according to this Installation information and regular calibration and maintenance by our factory-trained service team ensure dependable and accurate operation, protecting your investment. Contact us about a ServiceXXL agreement tailored to your needs and budget.

We invite you to register your product at www.mt.com/productregistration so we can contact you about enhancements, updates and important notifications concerning your product.

Contents		Page
1	General information	4
2	Safety instructions	5
2.1	Safety instructions for explosion protected weighing terminals IND4x9xx	5
2.2	Safety instructions for non-explosion-protected devices	7
3	Commissioning	8
3.1	Connecting analog weighing platforms.....	8
3.2	Connecting IDNet weighing platforms.....	10
3.3	Setting up the compact scale	11
3.4	Particular points when commissioning explosion protected weighing terminals	12
3.5	Connecting devices with a 12–24 V DC supply	12
4	Scale configuration	13
4.1	Calling up the service menu	13
4.2	Overview	14
4.3	Service menu operation	14
4.4	Description of the service menu	15
5	Commissioning and configuration of the interfaces	20
5.1	Configuration and testing of the Ethernet interface	20
5.2	Installing the drivers for the USB interface.....	21
5.3	Configuration of the WLAN interface	22
6	Structure of an analog weighing system	25
6.1	Selection of the weighing cell(s)	25
6.2	Measurement range of the terminals.....	28
7	Technical data	29
7.1	General technical data.....	29
7.2	Technical data of the analog scale interface	30
7.3	Assignment of the interface connections	31

1 General information

Documentation

The device is supplied with a CD containing the complete documentation on the IND4x9 / BBA4x9 series.

These installation instructions provide information on installing and commissioning the entire series.

IND4x9 / BBA4x9 weighing terminals and compact scales

	Normal version	Explosion protected version
Weighing terminals	IND429 IND439 IND449 IND439check IND449check+	IND429xx IND439xx IND449xx IND439xx check IND449xx check+
Compact scales	BBA429 BBA439check BBA449check+	–

Power supply variants

	Normal version	Explosion protected version
Built-in power supply unit	Standard	Standard
Built-in storage battery	Optional	Optional
External power supply 12–24 V DC	Optional	Optional
Via external storage battery	Optional (BBA4x9)	–

2 Safety instructions

2.1 Safety instructions for explosion protected weighing terminals IND4x9xx



The device fulfils Device category 3 and is approved for operation in Zone 2 (gases) and Zone 22 (dusts) hazardous areas.

There is an increased risk of injury and damage when used in hazardous areas. Special care must be taken when working in such hazardous areas. The code of practice is oriented to the "Safe Distribution" concept drawn up by METTLER TOLEDO.

- Competence**
- ▲ The device, accompanying weighing platforms and accessories may only be installed, maintained and repaired by authorised METTLER TOLEDO service personnel.
 - ▲ The mains connection may only be connected or disconnected by the owner's electrician.
- Ex approval**
- ▲ For the exact specification please refer to the statement of conformity.
 - ▲ No modifications may be made to the terminal and no repair work may be performed on the modules. Any weighing platform or system modules that are used must comply with the specifications contained in the installation instructions. Non-compliant equipment jeopardizes the safety of the system, cancels the Ex approval and renders any warranty or product liability claims null and void.
 - ▲ The cable glands must be tightened so that a strain relief of ≥ 20 N per mm cable diameter is ensured.
 - ▲ Ensure that the supply voltage at the installation site amounts to 230 V.
 - ▲ When connecting external devices, always observe the maximum permissible connected loads, see Page 29. It must be ensured that no voltages are fed into the device than it itself provides. The interface parameters have to fulfil the standard.
 - ▲ Peripheral devices without an Ex approval may only be operating in non-hazardous areas. It must be ensured that no voltages are fed into the device than it itself provides. In addition the maximum permissible connected loads have to be observed, see Page 29. The interface parameters have to fulfil the standard.
 - ▲ The safety of a weighing system is only guaranteed when the weighing system is operated, installed and maintained in accordance with the respective instructions.
 - ▲ Also comply with the following:
 - the instructions for the system modules
 - the regulations and standards in the respective country
 - the statutory requirement for electrical equipment installed in hazardous areas in the respective country
 - all instructions related to safety issued by the owner
 - ▲ Before initial start-up and following service work, check the explosion-protected weighing system for the proper condition of all safety-related parts.

Installation and retrofitting

- ▲ Only install or perform maintenance work on the weighing terminal, accompanying weighing platforms and accessories in the hazardous zone if the following conditions are fulfilled:
 - the owner has issued a permit ("spark permit" or "fire permit"),
 - the area has been rendered safe and the owner's safety co-ordinator has confirmed that there is no danger,
 - the necessary tools and any required protective clothing are provided (danger of the build-up of static electricity).
- ▲ The certification papers (certificates, manufacturer's declarations) must be present.
- ▲ Connection values of externally connectable devices and cables of other manufacturers must be known, e.g. capacitances, inductances and current consumption.
- ▲ Lay cables in such a way that they are protected from damage.
- ▲ Only route cables into the housing of the system modules via the earthing cable gland or METTLER TOLEDO plug and ensure proper seating of the seals. Ensure that the cable shields are connected correctly and that they have a secure connection to the housing.
- ▲ If the device is used in conjunction with an automatic or manual filling plant, all of the system modules must be equipped with a permanently wired emergency stop circuit, independent of the system circuit, in order to prevent personal injury or damage to other items of equipment.
- ▲ Establish an equipotential bonding.
- ▲ If the weighing platforms are installed in a pit, test whether primary explosion protection is required.
- ▲ Cover unused connection sockets with protective caps.
- ▲ Mount the labelling for operation in hazardous areas, see Section 3.4.3.
- ▲ After connectors have been mounted, screw on the securing clamps for external connectors.

Operation

- ▲ Prevent the build-up of static electricity. Therefore:
 - Always wear suitable working clothes when operating or performing service work on the system.
 - Do not rub or wipe off the keyboard surface with a dry cloth or glove.
- ▲ Do not use protective hoods.
- ▲ Prevent damage to the weighing terminal. Hairline cracks in the keyboard membrane are also considered damage.
- ▲ If the weighing terminal, accompanying weighing platforms or accessories are damaged:
 - Switch off the weighing terminal
 - Separate the weighing terminal from the mains in accordance with the applicable regulations
 - Secure the weighing terminal against accidental start-up
- ▲ Always charge the storage batteries in a safe zone.



2.2 Safety instructions for non-explosion-protected devices

- ▲ Do not use the device in a hazardous environment!
Special devices are available in our range of products for hazardous environments.
- ▲ Ensure that the power socket outlet for the device is earthed and easily accessible, so that it can be de-energized rapidly in emergencies.
- ▲ Ensure that the supply voltage at the installation site lies within in the range of 100 V to 240 V.
- ▲ The safety of the device cannot be ensured if it is not operated in accordance with these operating instructions.
- ▲ Only authorised personnel may open the device.
- ▲ Check the power cable regularly for damage. If it is damaged, disconnect the device immediately from the power supply.
- ▲ Ensure that there is a space of at least 3 cm at the rear in order to prevent the power cable from being bent too strongly.

3 Commissioning

3.1 Connecting analog weighing platforms

Any analog weighing platforms that fulfil the required specifications can be connected to weighing terminals with an analog weighing interface, see Section 7.2. Weighing platforms for hazardous areas require the corresponding approval.

3.1.1 Information on the weighing cells

Weighing cells with or without SENSE cables

→ In the case of cells without SENSE cables short-circuit the connections +Ex (Excitation) and +Se (Sense) or –Ex and –Se at the connector or at the connection terminal.

Cells without SENSE cables

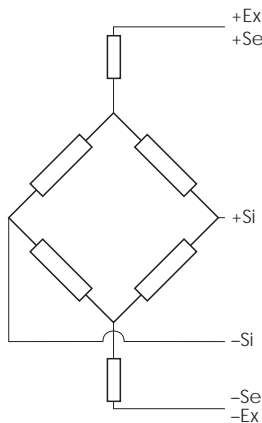

Cells with SENSE cables

required for certifiable weighing systems

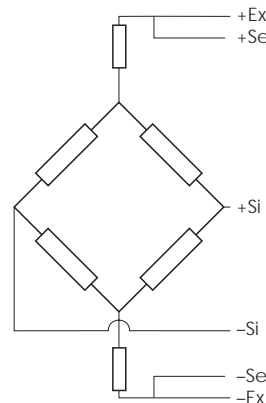

3.1.2 Connection of weighing platforms with several weighing cells

Up to four weighing cells can be connected to a weighing terminal in parallel. A junction box is usually used to connect several weighing cells.

The sum of the nominal capacities of the individual cells corresponds to the total capacity of the weighing system. When entering the scale capacities in the menu (Section 4.4.5), select values in such a way that the individual cells cannot be overloaded.

3.1.3 Preparation of the weighing platform connection cable

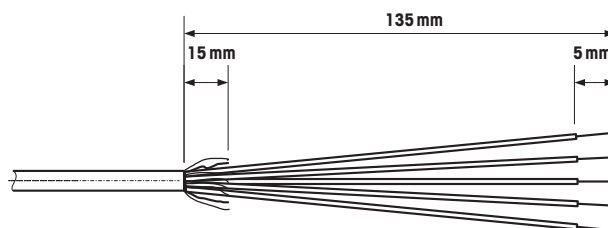

→ Strip the cell cable in accordance with the figure.

3.1.4 Connection of an analog weighing platform to the weighing terminal

The weighing terminals IND439 / IND439xx and IND449 / IND449xx can be equipped with a second analog weighing interface.

The connection of a second weighing platform requires that a weighing platform already be connected directly to the weighing terminal.



DANGER OF ELECTRIC SHOCK

→ Disconnect the weighing terminal from the power supply before beginning installation work.

Opening the weighing terminal and drawing in the weighing platform cable

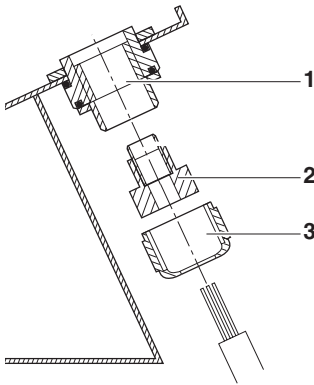

1. In the case of explosion protected weighing terminals remove the plug protection strip at the rear of the terminal.
2. Open the terminal. To do so, unscrew the hex bolts and lay the cover down. When doing so, take care of the cable connections.
3. Remove the cable gland of the desired scale connection and the blind plugs from the cable gland.
4. Slide the union nut (3) and moulded seal (2) over the cable sheathing. If any braided screen cores loosen in the process, these may not contact any conductive system parts.
5. Unbraid the exposed screen and place it evenly over the moulded seal (2).
6. Insert the moulded seal with the cable into the anti-twist guard of the metal housing (1).
7. Screw the union nut onto the metal housing and tighten it.

Connecting the first analog weighing platform

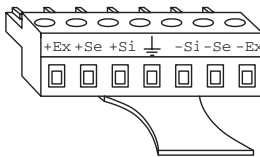

Si = Signal
Ex = Excitation
Se = Sense

1. Pull off the green 7-pin connector in the weighing terminal. The connector has a tab that facilitates its removal and plugging.
2. Fasten the conductors of the connecting cable to the connector. The connector assignment is shown in the adjacent figure.
The 7-pin connector has an additional connection in the middle for the signal earth. The signal earth can optionally be applied to this connection or to the screening and moulded seal (2).
When connecting METTLER TOLEDO weighing platforms observe the connection scheme supplied with the weighing platform.
3. Plug the connector in the weighing terminal. Ensure that the connector sits exactly centred on the socket. Otherwise not all the pins contact.

Connecting the second analog weighing platform (only IND439 / IND439xx and IND449 / IND449xx)

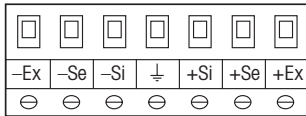

→ Connect the conductors of the connecting cable to the 7-pin terminal block on the second analog PCB. The terminal assignment is shown in the adjacent figure. The 7-pin terminal block has an additional connection in the middle for the signal earth. The signal earth can optionally be applied to this connection or to the screening.

When connecting METTLER TOLEDO weighing platforms observe the connection scheme supplied with the weighing platform.

- Note**
- In the factory setting the second scale is configured as a quantity scale (BULK). REF (reference scale) or AUXILIARY (auxiliary scale) can be selected instead in the COMMUNICATION → OPTION → MODE interface menu. The BYPASS setting can be used to de-activate the weighing platform.
 - Subsequently calibrate the second analog weighing platform (SCALE 2).

Closing the terminal

1. Position the cover and screw on the hex bolts. Ensure that no cables are pinched and that the cover sealing ring is positioned correctly.
2. Tighten the union nut of the heavy-gauge screw joint(s).
3. In the case of explosion protected weighing terminals mount the plug protection strip over the connections at the rear of the terminal.

3.2 Connecting IDNet weighing platforms

Alternatively to the analog scale connection the weighing terminals can also be equipped with IDNet scale interfaces. At IND439/IND439xx and IND449/IND449xx a second IDNet weighing platform can be connected optionally.

Information about two-scales systems

The scale with the higher address is defined by the weighing terminal as the second scale, irrespective of the socket to which the scale is connected. When brand new scales are commissioned, the weighing terminal automatically assigns an address. If an IDNet scale already has an address, this can be reset in the scale service mode (RES ALL). In the process the ID code is increased at certified scales.

Procedure

1. Set up the (first) weighing platform, refer to the installation instructions of the weighing platform.
2. Lay the weighing platform cable to the weighing terminal.
3. Ensure that the weighing terminal is switched off.
4. In the case of explosion protected devices remove the plug protection strip at the rear.
5. Plug the weighing platform connector into the weighing terminal and tighten the screws.
6. Switch on the weighing platform. This weighing platform has the scale number 1.
7. If necessary, repeat Steps 1 to 6 for the second scale. Scale number 2 is assigned to the second scale.
8. In the case of explosion protected devices mount the plug protection strip over the connections at the rear.

Note In the factory setting the second scale is configured as a quantity scale (BULK). REF (reference scale) or AUXILIARY (auxiliary scale) can be selected instead in the COMMUNICATION → OPTION → MODE interface menu. The BYPASS setting can be used to de-activate the weighing platform.

3.3 Setting up the compact scale

1. Set up the compact scale at the desired installation site.
2. Level the compact scale; refer to the PBA430 weighing platform operating instructions.

3.4 Particular points when commissioning explosion protected weighing terminals

3.4.1 Equipotential bonding

The equipotential bonding must be installed by a professional electrician when using the weighing platforms in hazardous areas.

- Connect equipotential bonding of all devices in accordance with the country-specific regulations and standards. In the process, make sure that all device housings are connected to the same potential via the PA terminals.

Weighing terminal equipotential bonding terminal

The equipotential bonding clamp of the weighing terminal is found on the COM1 socket.

3.4.2 Limited mobility



EXPLOSION HAZARD

The device may only be operated in Zone 2 and 22 hazardous areas.

Cabling

- Protect data and signal cable extensions against inadvertent disconnection.
- Secure the interface connections on the rear using the plug protection strip.

3.4.3 Labelling for operation in a hazardous area

The following signs must be mounted on the weighing terminal, accompanying weighing platforms and accessories so that they are clearly visible:

- Model plate with the device's model data, manufacturer and serial number
- Safety instructions
- Explosion protection identification
- If appropriate, temperature range

3.5 Connecting devices with a 12–24 V DC supply

Explosion protected IND429xx weighing terminals are supplied with a fixed-mounted 2.5 m long connecting cable with open ends.





Non-explosion-protected devices are equipped with a socket for connecting the power supply. A connecting cable with open ends is included with the device.

Connected values	12 V DC – 24 V DC, max. 800 mA
Connection end	Open ends
Colour code	Brown – plus White – minus

4 Scale configuration

4.1 Calling up the service menu

4.1.1 At non-certifiable analog scales and IDNet scales

1. Press and hold  until CODE appears.
2. Enter the service password    .

The SCALE menu item is displayed.

Note

Access to the service menu is secured by means of a software seal (ID code) at IDNet scales. If changes are carried out at a scale that is set to certifiable, the ID code is increased by 1 and stored in the scale. After configuration has been terminated, the ID code at the connector of the scale has to be set to the same value as the stored one. This setting has to be stored by certifiable means.

4.1.2 At certifiable analog scales

Due to metrological regulations direct access to the service menu (technician mode) is blocked at certified or certifiable scales. The calibration seal is destroyed when the device is opened. After the configuration has been completed, the device has to be recalibrated by an authorised company and a new calibration seal attached before it may be used again as a calibrated scale.



DANGER OF ELECTRIC SHOCK

The power supply unit under the power supply unit cover is energized.

→ Do not carry out service work on the power supply unit and mains cable.

Procedure

1. Devices with power connection: Disconnect from the power supply. Devices with storage battery: Switch off.
2. Open the housing cover.
3. Remove the cover and set it down or fix it. When doing so, take care of the cable connections.
4. Devices with power connection: Connect to the power supply. Devices with storage battery: Switch on.
5. Press the Pushbutton 1 on the PCB of the first scale interface. Use a suitable tool to this purpose, for example, the blunt end of a pencil.
The device starts up and the first block of the SCALE servicemenu is displayed.
6. Replace the cover and carry out the service settings.
7. After the settings have been completed, disconnect the power plug again at devices with a power connection.
8. Close the housing cover with the hex bolts. Ensure proper seating of the cover sealing ring when doing so.

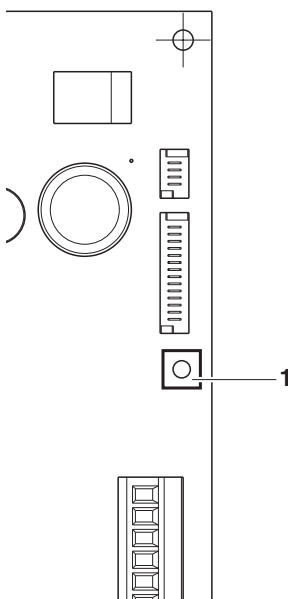

4.2 Overview

After the service menu has been called up, the entire menu is available, also the user and supervisor menu. The following overview shows the **SCALE** menu block, the remaining menu is described in the operating instructions.

Note

Only the menu blocks **in bold** are displayed at **IDNet scales**. At IDNet scales the service mode of the scale is shown after **SCALE (1/2)** has been selected. The query **rEtUrN?** appears. With  **SNr** is displayed as the next menu item.





Block		Meaning	Page
SCALE	MEtrOLO	Determining the admissibility for certification	15
	SCALE 1 / SCALE 2	Selection of the scale to be configured, is only displayed at two-scale systems	15
	rAMP	Display of the excursion of the A/D converter (ramp)	15
	SNr	Query/Modification of the serial number	15
	SCAL.bLd	Input of the configuration data	16
	GEO	Setting of the Geo value	16
	LIN-CAL	Linearization with calibration	18
	CAL	Basic calibration	18
	CONtrOL	Activation of the control mode	18
	ZErO	Settings for the zero point	19
	Min.WEiG	Setting the minimum weighing-in quantity	19

4.3 Service menu operation

Operation in the service menu is the same as in the user and supervisor menu.

Numerical values, for example capacity, can be entered via the numerical keypad, if present.

Numerical input at devices without number block

1. Press the  key in order to activate the input.
The first number begins to flash.
2. Change the number using the  and  keys.
3. Confirm the modified number with the  key.
The next number begins to flash.
4. Repeat Steps 2 and 3 until all the numbers have been entered.

4.4 Description of the service menu

4.4.1 Admissibility for certification

MEtrOLO NO APPr OIML ntEP	Setting the admissibility for certification Scale not certifiable Certify scale to OIML Certify scale to NTEP, valid for the USA
Note	If a scale is certified, various scale settings are no longer available or are only available to a limited extent. Direct access to the menu for service personnel is, furthermore, blocked subsequently.

4.4.2 SCALE1/SCALE2 – Selecting a scale

This menu item appears only if a second scale or weighing platform is connected.

4.4.3 Querying the value of the A/D converter

rAMP rMP 20	Display of the percentage deflection of the analog/digital converter (ramp)
Note	This value can be used to determine whether the weighing cell operates correctly. Scales with identical and a weighing cell that functions correctly have more or less the same ramp values. The value is dynamic and changes when the load changes.

4.4.4 Querying the serial number of the terminal or compact scale

SNr 1234567	Display or modification of the serial number.
Note	The serial number should not be changed except, for example, after a new main printed circuit board has been installed.

4.4.5 Entering configuration data

SCAL.bLd	Input of the configuration data
SCAL.tYP	Defining the scale type
SINGLE.r	Single Range: Single-range scale
2MULt.IN	Multi interval: Scale with rough range and 1 shiftable fine range. Automatic switching between the ranges in both directions.
2MULt.rN	Multi Range: Scale with rough range and 1 fixed fine range. Automatic change to the rough range. Return to the fine range at zero pass.
3MULt.IN	Multi Interval: Scale with rough range and 2 shiftable fine ranges
3MULt.rN	Multi Range: Scale with rough range and 2 fixed fine ranges.
bAS.UNIt	Specify the basic unit for entering in the service menu
g	Grams
kg	Kilograms
oz	Ounces
lb	Pounds
t	Tons
SCL.CAP	Entry of the scale capacity in the selected basic unit
rESOL	Selection of the resolution in the selected basic unit The available resolutions depend on the capacity of the weighing system.
Note	In case of multi-range or multi-interval scales the blocks SCL.CAP and rESOL are available separately for each range. They are displayed in the following sequence: SCL.CAP 1, rESOL 1, SCL.CAP 2, rESOL 2, SCL.CAP 3, rESOL 3



4.4.6 Setting the Geo value

GEO	The Geo value is used to adapt the weighing system to the local gravity conditions.
0 ... 31	Setting range: 0 ... 31, see following table





Table of Geo values

Northern or southern latitude in degrees and minutes	Height above sea level in meters										
	0	325	650	975	1300	1625	1950	2275	2600	2925	3250
	325	650	975	1300	1625	1950	2275	2600	2925	3250	3575
	Height above sea level in feet										
0	1060	2130	3200	4260	5330	6400	7460	8530	9600	10660	
1060	2130	3200	4260	5330	6400	7460	8530	9600	10660	11730	
0° 0' – 5° 46'	5	4	4	3	3	2	2	1	1	0	0
5° 46' – 9° 52'	5	5	4	4	3	3	2	2	1	1	0
9° 52' – 12° 44'	6	5	5	4	4	3	3	2	2	1	1
12° 44' – 15° 6'	6	6	5	5	4	4	3	3	2	2	1
15° 6' – 17° 10'	7	6	6	5	5	4	4	3	3	2	2
17° 10' – 19° 2'	7	7	6	6	5	5	4	4	3	3	2
19° 2' – 20° 45'	8	7	7	6	6	5	5	4	4	3	3
20° 45' – 22° 22'	8	8	7	7	6	6	5	5	4	4	3
22° 22' – 23° 54'	9	8	8	7	7	6	6	5	5	4	4
23° 54' – 25° 21'	9	9	8	8	7	7	6	6	5	5	4
25° 21' – 26° 45'	10	9	9	8	8	7	7	6	6	5	5
26° 45' – 28° 6'	10	10	9	9	8	8	7	7	6	6	5
28° 6' – 29° 25'	11	10	10	9	9	8	8	7	7	6	6
29° 25' – 30° 41'	11	11	10	10	9	9	8	8	7	7	6
30° 41' – 31° 56'	12	11	11	10	10	9	9	8	8	7	7
31° 56' – 33° 9'	12	12	11	11	10	10	9	9	8	8	7
33° 9' – 34° 21'	13	12	12	11	11	10	10	9	9	8	8
34° 21' – 35° 31'	13	13	12	12	11	11	10	10	9	9	8
35° 31' – 36° 41'	14	13	13	12	12	11	11	10	10	9	9
36° 41' – 37° 50'	14	14	13	13	12	12	11	11	10	10	9
37° 50' – 38° 58'	15	14	14	13	13	12	12	11	11	10	10
38° 58' – 40° 5'	15	15	14	14	13	13	12	12	11	11	10
40° 5' – 41° 12'	16	15	15	14	14	13	13	12	12	11	11
41° 12' – 42° 19'	16	16	15	15	14	14	13	13	12	12	11
42° 19' – 43° 26'	17	16	16	15	15	14	14	13	13	12	12
43° 26' – 44° 32'	17	17	16	16	15	15	14	14	13	13	12
44° 32' – 45° 38'	18	17	17	16	16	15	15	14	14	13	13
45° 38' – 46° 45'	18	18	17	17	16	16	15	15	14	14	13
46° 45' – 47° 51'	19	18	18	17	17	16	16	15	15	14	14
47° 51' – 48° 58'	19	19	18	18	17	17	16	16	15	15	14
48° 58' – 50° 6'	20	19	19	18	18	17	17	16	16	15	15
50° 6' – 51° 13'	20	20	19	19	18	18	17	17	16	16	15
51° 13' – 52° 22'	21	20	20	19	19	18	18	17	17	16	16
52° 22' – 53° 31'	21	21	20	20	19	19	18	18	17	17	16
53° 31' – 54° 41'	22	21	21	20	20	19	19	18	18	17	17
54° 41' – 55° 52'	22	22	21	21	20	20	19	19	18	18	17
55° 52' – 57° 4'	23	22	22	21	21	20	20	19	19	18	18
57° 4' – 58° 17'	23	23	22	22	21	21	20	20	19	19	18
58° 17' – 59° 32'	24	23	23	22	22	21	21	20	20	19	19
59° 32' – 60° 49'	24	24	23	23	22	22	21	21	20	20	19
60° 49' – 62° 9'	25	24	24	23	23	22	22	21	21	20	20
62° 9' – 63° 30'	25	25	24	24	23	23	22	22	21	21	20
63° 30' – 64° 55'	26	25	25	24	24	23	23	22	22	21	21
64° 55' – 66° 24'	26	26	25	25	24	24	23	23	22	22	21
66° 24' – 67° 57'	27	26	26	25	25	24	24	23	23	22	22
67° 57' – 69° 35'	27	27	26	26	25	25	24	24	23	23	22
69° 35' – 71° 21'	28	27	27	26	26	25	25	24	24	23	23
71° 21' – 73° 16'	28	28	27	27	26	26	25	25	24	24	23
73° 16' – 75° 24'	29	28	28	27	27	26	26	25	25	24	24
75° 24' – 77° 52'	29	29	28	28	27	27	26	26	25	25	24
77° 52' – 80° 56'	30	29	29	28	28	27	27	26	26	25	25
80° 56' – 85° 45'	30	30	29	29	28	28	27	27	26	26	25
85° 45' – 90° 00'	31	30	30	29	29	28	28	27	27	26	26

4.4.7 Linearization with simultaneous calibration

<p>LIN-CAL</p> <p>3 POINT / 5 POINT</p>	<p>A basic calibration must have been carried out at least once for linearization with simultaneous calibration.</p> <p>→ If available, apply the preload.</p> <ul style="list-style-type: none"> • 3-point linearization (by default at 0 %, 50 % and 100 % of the full load) • 5-point linearization (by default at 0 %, 25 %, 50 %, 75 % and 100 % of the full load) <ol style="list-style-type: none"> 1. Confirm the type of linearization. The display begins to flash, the scale determines the zero point automatically. The scale next requests the first weight. 2. If appropriate, change the displayed weight value. 3. Place the displayed weight on the scale and confirm with . 4. Repeat Steps 2 and 3 for each additional sample. After all the weights have been applied, done is displayed.
Notes	<ul style="list-style-type: none"> • Determining the zero point can be skipped by pressing . In this case the existing zero point is used as the reference. • Linearization/calibration can be cancelled at any time with the  key.



4.4.8 Basic calibration

<p>CAL</p> <p>PrELoad</p>	<p>Calibration can be carried out with preload in basic calibration.</p> <ol style="list-style-type: none"> 1. Load the desired preload and confirm with . The scale next requests the calibration weight corresponding to the full load. 2. If appropriate, change the displayed weight value. 3. Place the displayed weight on the scale and confirm with . After calibration has been carried out, done is displayed.
Notes	<ul style="list-style-type: none"> • Determining the preload can be skipped with . In this case the existing zero point is used as the reference. • Calibration can be cancelled at any time with the  key. • In order to achieve particularly high precision carry out calibration under full load.

4.4.9 Activating the control mode

<p>CONtROL</p>	<p>In control mode the current weighing result is displayed with a high resolution and without a weight unit. This allows the scale to be checked, for example after calibration and/or linearization.</p>
----------------	--

4.4.10 Settings for the zero point

ZErO	Settings for the zero point
Z-CAPt	Specify the zero capturing range -2 18 Zero capturing range -2 % to +18 % -2 2 Zero capturing range -2 % to +2 %, mainly for certifiable scales
SEt.ZErO	Move the calibration zero point. This is necessary if an auxiliary preload is used or if the preload (for example roller conveyor) cannot be used for calibration or if they lie outside the zero capturing range. 1. Apply the preload and confirm with  . The query SURF is displayed. 2. Confirm moving of the zero point with  or cancel with  . 3. If underload or overload is displayed after the menu has been exited, switch the device off and on again.
AZM	Setting for the automatic zero compensation mode, refer to the operating instructions.
Note	The zero capturing range limits the nominal capacity of the scale. If the capacity of a weighing cell is to be used to its complete extent, the zero capturing range can be limited to -2 % to +2 %.

4.4.11 Specifying the minimum weighing-in quantity

Min.WEiG	Entry of the minimum weighing-in quantity in the selected basic unit. When the minimum weighing-in quantity is activated, * is displayed if the weight on the scale falls below the stored minimum weight.
----------	---

5 Commissioning and configuration of the interfaces

5.1 Configuration and testing of the Ethernet interface

5.1.1 Configuration of the Ethernet interface in the menu of IND4x9 / BBA4x9

The configuration of the Ethernet interface in the menu is described in the operating instructions (COMMUNI → OPTION → ETHERNET).

Ask your network administrator for the correct settings for the IP address, subnet mask and gateway.

5.1.2 Establishing a network connection between the Ethernet interface and the PC

If the PC is already connected via a switch/hub to the network, no further settings are required for the network card in the PC.

In the case of a direct connection between the Ethernet interface and the PC via a cross-patch cable the settings for the TCP/IP Internet protocol have to be observed.

1. Call up Start → Control Panel → Network Connection.
2. Select "Local Area Connection" and right-click it to select "Properties".
3. Select "Internet Protocol (TCP/IP)" and click "Properties".
4. Enter the IP address, subnet mask and gateway in accordance with the settings in the menu.

5.1.3 Testing the Ethernet interface

The "Ping" command can be used to check whether a user exists in the network and can also be addressed.

1. Open a DOS box (command prompt) at the PC (Start → Run).
2. Enter the "Ping" command followed by the IP address at the weighing terminal or compact scale.
With the default address the command is as follows: Ping 192.168.1.1
3. The answer is, for example, Bytes = 32, Time = 2 ms, TTL = 64.
If no response appears, repeat the command with correct entries.

5.1.4 Establishing a connection with HyperTerminal

1. Select the DIALOG setting for the Ethernet interface in the menu under COMMUNI → COM2 → MODE.
2. Start HyperTerminal and create a new connection.
3. Select "TCP/IP (Winsock)", specify the IP address of the Ethernet interface (factory setting: 192.168.1.1) enter the port number (factory setting: 8000).
4. Select the following settings under "File → Properties → Settings → ASCII Configuration":
 - Transmitted characters end with line feed
 - Output entered characters locally (local echo)
 - Write lines that are too long in the terminal window

SICS commands can now be transmitted at the weighing terminal or compact scale.

5.1.5 Configuration of the Ethernet interface via a Web browser

The Ethernet interface is equipped with a Web server through which the further settings can be carried out.

1. Start a Web browser on the PC, for example Internet Explorer, and enter "http://192.168.1.1" as the target address.
The starting page of the Ethernet Web server is displayed.
2. Use the "Client Server → Help" menu item to call up further information on setting the Ethernet interface.

5.2 Installing the drivers for the USB interface

For weighing terminals or compact scales with a USB interface a CD with the required drivers is provided additionally. The drivers are installed in two steps. The following section describes the installation for a PC with Windows XP.

5.2.1 Installing USB drivers

1. Connect the USB interface of the weighing terminal or compact scale to the PC with a USB cable.
The message "New hardware found" is displayed at Windows XP.
2. Insert the supplied CD into the PC.
The wizard for searching for new hardware is displayed.
3. Select "Install software from a list or specific location (for advanced users)" in the initial screen and click "Next".
4. In the next step select "Browse removable media (floppy disk, CD, etc.)" and click "Next".
The required files are searched for and copied.

A warning is displayed since the drivers on the CD ROM have not been certified by Microsoft WHQL. However, the drivers were tested extensively by METTLER TOLEDO and are suitable for installation under Windows XP.

5. Click "Continue Anyway".
6. Click "Finish" in the next screen.
The installation is completed. The message "New hardware found" is displayed.

Subsequently The VCP driver still has to be installed subsequently.

5.2.2 Installing VCP drivers

The wizard for searching for new hardware is displayed again.

- Repeat Steps 3 to 6 as described under Section 5.2.1 for the VCP driver.

5.2.3 Setting the Virtual COM Port (VCP)

The installation of the VCP driver makes an additional serial interface available on the PC. This interface can be used to access weighing terminals or compact scales with a USB interface.

1. Call up "Start → Control Panel" and double-click "System".
2. Select the "Hardware" tab and click the "Device Manager".
3. Search for the entry "Ports (COM & LPT)" and click the adjacent "+" symbol. All the available ports are displayed.
4. Double-click "METTLER TOLEDO Serial Port". The "Properties of METTLER TOLEDO Serial Port" screen is displayed.
5. Select the "Port settings" tab and click "Advanced".
6. Select the desired COM port number from the drop-down menu list and confirm with "OK".

5.2.4 Establishing a connection with HyperTerminal

1. Select the DIALOG setting for the USB interface in the menu under COMMUNI → COM2 → MODE.
2. Start HyperTerminal and create a new connection.
3. Select the desired COM port number and carry out the following settings: 9600 bits/s, 8 data bits, no parity, protocol Xon/Xoff.
4. Select the following settings under "File → Properties → Settings → ASCII Configuration":
 - Transmitted characters end with line feed
 - Output entered characters locally (local echo)
 - Write lines that are too long in the terminal window

SICS commands can now be transmitted at the weighing terminal or compact scale.

5.3 Configuration of the WLAN interface

The following section describes the installation for a PC with Windows XP. It is assumed that the WLAN interface of the weighing terminal or compact scale is in the state of delivery with the following network parameters:

IP address 192.168.0.1
Subnet 255.255.255.0
Gateway 0.0.0.0

5.3.1 Configuration of the WLAN interface in the menu of IND4x9 / BBA4x9

The configuration of the WLAN interface in the menu is described in the operating instructions (COMMUNI → OPTION → WLAN).

Ask your network administrator for the correct settings for the IP address, subnet mask and gateway in the encrypted company network.

5.3.2 Establishing an ad-hoc connection to the WLAN network

1. Ensure that the weighing terminal or the compact scale with the WLAN interface is switched off.
2. Call up the WLAN configuration program on the PC and carry out the following settings.
 - Set the SSID to "Connect".
 - Select no encryption.
 - Set the parameters for the ad-hoc connection: 2.4 GHz, 11 Mbps.
 - Ensure that a free channel is used or that the channel is selected automatically.
 - Ensure that no WLAN connection is active.
3. Ensure that no further network connections are active, for example LAN connection via Ethernet cable.
4. Call up Start → Control Panel → Network Connection.
5. Select "Wireless Network Connection" and click "Internet Protocol (TCP/IP)".
6. Click "Properties" and carry out the following settings:
 - Set the IP address 192.168.0.10.
A different IP address can also be selected in the subnet 192.168.0.x. The IP address of the weighing terminal or compact scale with WLAN interface (192.168.0.1) may not be selected.
 - Subnet mask: 255.255.255.0.
 - No gateway setting
7. Call up the WLAN configuration program on the PC and activate the WLAN connection.
8. Switch on the weighing terminal or compact scale with WLAN interface.

The WLAN interface is equipped with a Web server through which the further settings can be carried out.

5.3.3 Configuration via Web browser

1. When an active ad-hoc connection is displayed at the PC, start a Web browser on the PC, for example the Internet Explorer.
2. Enter the target address "http://192.168.0.1".
The log-on page of the WLAN Web user interface is displayed.
3. Log on with the user name "admin" and the password "admin".
4. Carry out the network settings for the encrypted company network under Configuration → Network.

5.3.4 Establishing a connection with HyperTerminal

1. Select the DIALOG setting for the WLAN interface in the menu under COMMUNI → COM2 → MODE.
2. Start HyperTerminal and create a new connection.
3. Select "TCP/IP (Winsock)", specify the IP address of the WLAN interface (factory setting: 192.168.0.1) and enter the port number (factory setting: 2101).
4. Select the following settings under "File → Properties → Settings → ASCII Configuration":
 - Transmitted characters end with line feed
 - Output entered characters locally (local echo)
 - Write lines that are too long in the terminal window

SICS commands can now be transmitted at the weighing terminal or compact scale.

6 Structure of an analog weighing system

6.1 Selection of the weighing cell(s)

The following data are required to determine the capacity of the weighing cell:

- **Scale capacity** – Usually corresponds to the heaviest weighing sample that is to be weighed using the weighing system.
- **Preload** – Contains the total weight of all the parts that lie on the weighing cell. These include the top section of the weighing platform, the weighing pan and all the assemblies, such as a roller conveyor, weighing vessel etc.
- **Total zero setting range** – Consists of the desired activation zero capturing range (+18/-2 % or +/-2 %) and the zero setting range available to the user through the  key (2 %). The total zero-set range thus amounts to either 20 % or 4 % of the scale capacity.

The addition of the scale capacity, preload and total zero setting range results in the required capacity of the weighing cell. It is advisable to include an additional safety margin in order to avoid overloading of the weighing cell.

Total capacity of the weighing cell(s) = Scale capacity + Preload + Total zero setting range + Safety margin

In the case of **systems with several weighing cells** divide the determined total capacity by the number of cells in order to determine the capacity of the individual cell. A sufficiently large safety margin is particularly important if a strong load is to be expected in the corner areas of the scale so that the load is no longer distributed evenly amongst all the cells.

In the case of **systems with a lever mechanism** divide the determined total capacity by the transmission ratio of the lever mechanism in order to determine the capacity of the individual cell.

Take the following further parameters into consideration when selecting the weighing cell(s):

- The smallest desired display step
- Requirements for admissibility for certification, if necessary
- Number and type of the weighing ranges
- The approval for hazardous areas in the case of explosion protected weighing systems

The terminal provides a **supply voltage** of 8.2 V for the weighing cell(s). Depending on the sensitivity of the weighing cell this results in the following **maximum weighing signal** (product of supply voltage and sensitivity):

Sensitivity of the cell	2 mV/V	3 mV/V
Supply voltage	8.2 V	8.2 V
Max. weighing signal *	16.4 mV	24.6 mV *
Min. weighing signal per display step (for certifiable scales)	0.5 μ V/e	0.5 μ V/e

* Only 20 mV can be measured by the A/D converter. Therefore the max. weighing capacity may not exceed 81 % of the cell capacity.

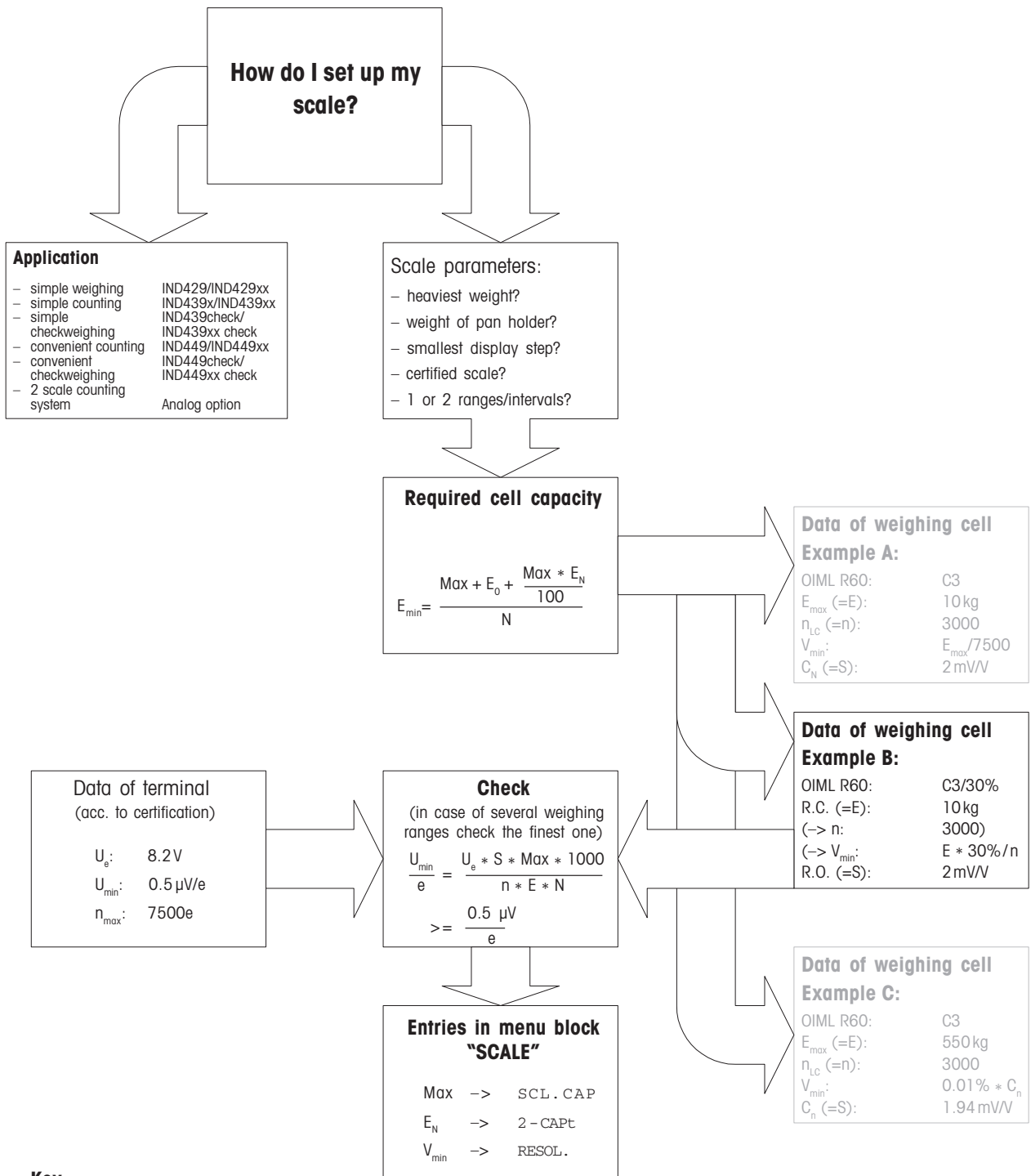

Key:

- | | |
|--|--|
| Max [kg]: weighing range | U _e [V]: power supply from terminal |
| N: no. of weighing cells | S [mV/V]: cell output signal |
| E ₀ [kg]: preload (weight of pan holder, container, etc.) | n [e]: resolution |
| E _N [%]: zero setting range (2%) + zero capturing range
(+18/-2% or ±2%) = 20% or 4% | E [kg]: load capacity of selected weighing cell |
| E _{min} [kg]: required load capacity per weighing cell | U _{min} [μV/e]: minimum voltage per verification interval |
| | n _{max} [e]: maximum resolution |
| | V _{min} [g]: display step |

6.2 Measurement range of the terminals

When designing a weighing system observe the measurement range of the terminal in accordance with the following overview.

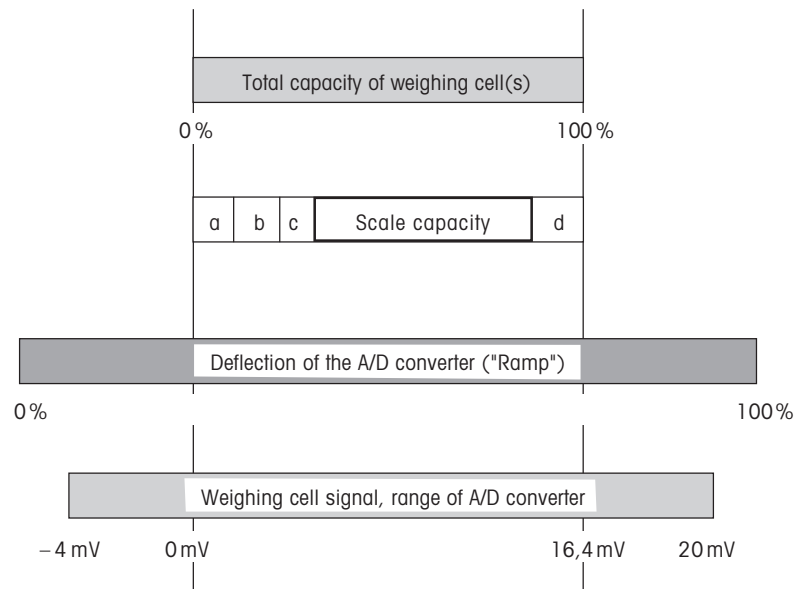

- a** Total preload applied to the weighing cell during calibration (platform top section, weighing pan, roller conveyor, etc.)
- b** Activation zero capturing range: $\pm 18\%$ or $\pm 2\%$ of the weighing capacity, can be selected in the menu
- c** Zero setting range with 0 key: $\pm 2\%$ of the scale capacity, cannot be modified
- d** Safety margin

7 Technical data

7.1 General technical data

Mains connection	<p>Direct connection to power supply (supply voltage fluctuation not exceeding $\pm 10\%$ of the rated voltage)</p> <ul style="list-style-type: none"> • Non-explosion-protected weighing terminals IND4x9: Rated voltage 100 ... 240 V AC / 47 ... 63 Hz / 300 mA • Explosion protected weighing terminals IND4x9xx: Rated voltage 230 V AC $\pm 10\%$ / 47 ... 63 Hz / 300 mA • Compact scales BBA4x9: Rated voltage 100 ... 240 V AC / 47 ... 63 Hz / 300 mA 														
Storage battery operation	<p>Supply at device: 24 V DC / 1.0 A</p> <p>If the supply voltage is interrupted, the scale switches automatically over to storage battery operation</p> <p>For operating life refer to the operating instructions</p>														
Ignition protection type IND4x9xx (to IEC 60079-15)	<ul style="list-style-type: none"> • Hazardous area Zone 2: Device category II 3G EEx nA II T4, Temperature range -10 °C ... +40 °C / 14 °F ... 104 °F • Hazardous area Zone 22: Device category II 3D IP66 T 70 °C 														
Ambient conditions	<table> <tr> <td>• Application</td> <td>In interiors</td> </tr> <tr> <td>• Height</td> <td>up to 2,000 m</td> </tr> <tr> <td>• Temperature range Class III</td> <td>-10 ... +40 °C / 14 ... 104 °F</td> </tr> <tr> <td>• Temperature range Class II</td> <td>0 ... +40 °C / 32 ... 104 °F</td> </tr> <tr> <td>• Overvoltage category</td> <td>II</td> </tr> <tr> <td>• Degree of soiling</td> <td>2</td> </tr> <tr> <td>• Relative humidity</td> <td>up to max. 80 %, non-condensing</td> </tr> </table>	• Application	In interiors	• Height	up to 2,000 m	• Temperature range Class III	-10 ... +40 °C / 14 ... 104 °F	• Temperature range Class II	0 ... +40 °C / 32 ... 104 °F	• Overvoltage category	II	• Degree of soiling	2	• Relative humidity	up to max. 80 %, non-condensing
• Application	In interiors														
• Height	up to 2,000 m														
• Temperature range Class III	-10 ... +40 °C / 14 ... 104 °F														
• Temperature range Class II	0 ... +40 °C / 32 ... 104 °F														
• Overvoltage category	II														
• Degree of soiling	2														
• Relative humidity	up to max. 80 %, non-condensing														
Interfaces	<ul style="list-style-type: none"> • 1 RS232 interface integrated • 1 further optional interface possible 														
Max. permissible connected values	<ul style="list-style-type: none"> • The total of the connected values of COM1 and COM2 may not exceed 100 mA • At an installed Ethernet option COM1 may not exceed 50 mA 														

7.2 Technical data of the analog scale interface

Analog scale interface	
Resolution	300,000 points for non-certifiable applications 7,500 points for certifiable applications
Weighing ranges	Up to 3 weighing ranges can be defined in the menu, incl. shiftable or fixed fine ranges. In the case of certifiable/certified applications the minimum voltage per calibration value (0.5 µV/e) has to be ensured or 7,500 e may not be exceeded.
Calibration	Basic calibration and calibration during linearization
Zero setting range (key)	2 % of the defined max. useable load, cannot be modified
Autozero range	2 % of the defined max. useable load, cannot be modified
Activation zero-set range	–2 % ... 18 % or –2 % ... 2 % referenced to the defined max. useable load can be selected in the menu
Linearity	0.01 % of the defined max. useable load
Units	g, kg, oz, lb, t
Numerical steps	1, 2, 5 x 10 ⁿ , can be selected in the menu
Cell power supply	8.2 V
Requirements for the weighing cell	
Nominal load	0.1 ... 999,999.9 (g, kg, lb, oz, t)
Permissible impedance	≥ 80 Ω
Differential signal	–1 mV ... 25 mV (see the following calculation example)

Calculation example for the differential signal

Data of the weighing cell: Sensitivity 2 mV/V, cell capacity 100 kg

Differential signal for nominal load (60 kg)

$$2 \text{ mV/V} * 8.2 \text{ V} * 60 \text{ kg}/100 \text{ kg} = 9.84 \text{ mV}$$

Differential signal for half load (30 kg)

$$2 \text{ mV/V} * 8.2 \text{ V} * 30 \text{ kg}/100 \text{ kg} = 4.92 \text{ mV}$$

Prerequisites for certifiable scales

- Certifiable weighing cell with SENSE cables (6 leads), Sensitivity of the cells 2 mV/V or 3 mV/V
- Scale configured in the Service menu as certifiable
- Labelling in accordance with regulations by the plant engineer, if the complete scale was not supplied by METTLER TOLEDO

7.3 Assignment of the interface connections

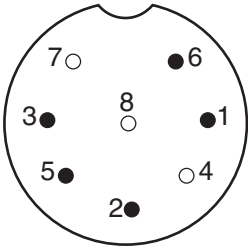
RS232	
<p>Socket</p>  <p>External view</p>	<p>8-pin circular plug, socket</p> <p>Pin 1 Shield</p> <p>Pin 2 TXD, scale transmission line</p> <p>Pin 3 RXD, scale reception line</p> <p>Pin 5 +5 V Factory setting: +5 V de-activated (OFF)</p> <p>Pin 6 GND</p>
Note	For max. connected values refer to Section 7.1

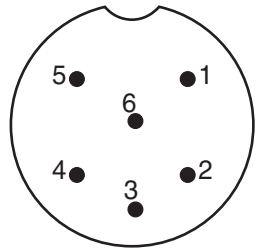
RS422/485																						
<p>Socket</p>  <p>External view</p>	<p>6-pin circular plug, socket</p> <table border="0"> <thead> <tr> <th></th> <th>RS422</th> <th>RS485</th> </tr> </thead> <tbody> <tr> <td>Pin 1</td> <td>GND</td> <td>GND</td> </tr> <tr> <td>Pin 2</td> <td>+5 V Factory setting: +5 V on (ON)</td> <td>+5 V Factory setting: +5 V on (ON)</td> </tr> <tr> <td>Pin 3</td> <td>TXD+</td> <td>TXD+/RXD+</td> </tr> <tr> <td>Pin 4</td> <td>TXD-</td> <td>TXD-/RXD-</td> </tr> <tr> <td>Pin 5</td> <td>RXD-</td> <td>-</td> </tr> <tr> <td>Pin 6</td> <td>RXD+</td> <td>-</td> </tr> </tbody> </table>		RS422	RS485	Pin 1	GND	GND	Pin 2	+5 V Factory setting: +5 V on (ON)	+5 V Factory setting: +5 V on (ON)	Pin 3	TXD+	TXD+/RXD+	Pin 4	TXD-	TXD-/RXD-	Pin 5	RXD-	-	Pin 6	RXD+	-
	RS422	RS485																				
Pin 1	GND	GND																				
Pin 2	+5 V Factory setting: +5 V on (ON)	+5 V Factory setting: +5 V on (ON)																				
Pin 3	TXD+	TXD+/RXD+																				
Pin 4	TXD-	TXD-/RXD-																				
Pin 5	RXD-	-																				
Pin 6	RXD+	-																				
Note	For max. connected values refer to Section 7.1																					

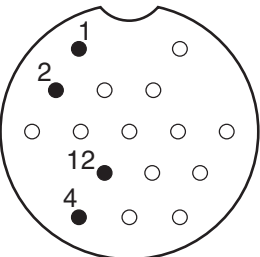
Ethernet	
<p>Socket</p>  <p>External view</p>	<p>16-pin circular plug, socket</p> <p>Pin 1 TX+</p> <p>Pin 2 TX-</p> <p>Pin 4 RX-</p> <p>Pin 12 RX+</p>
Note	For max. connected values refer to Section 7.1

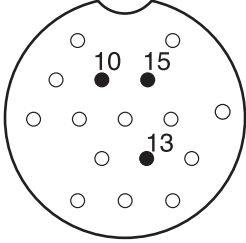
USB	
<p>Socket</p>  <p>External view</p>	<p>16-pin circular plug, socket</p> <p>Pin 10 D-</p> <p>Pin 15 D+</p> <p>Pin 13 GND</p>

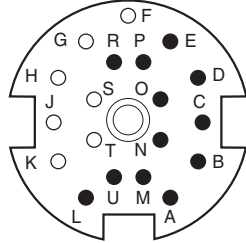
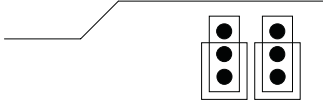
Digital I/O																																								
<p>Socket</p>  <p>External view</p>	<p>19-pin circular plug, socket</p> <table border="0"> <tr> <td></td> <td></td> <td style="text-align: right;">Cable</td> </tr> <tr> <td></td> <td></td> <td style="text-align: right;">00 504 458</td> </tr> <tr> <td></td> <td></td> <td style="text-align: right;">Black</td> </tr> <tr> <td>Pin A, L</td> <td>Not assigned or +12 V, max. 400 mA</td> <td></td> </tr> <tr> <td>Pin B</td> <td>Output 1</td> <td>White</td> </tr> <tr> <td>Pin C</td> <td>Output 2</td> <td>Brown</td> </tr> <tr> <td>Pin D</td> <td>Output 3</td> <td>Green</td> </tr> <tr> <td>Pin E</td> <td>Output 4</td> <td>Yellow</td> </tr> <tr> <td>Pin M, U *</td> <td>Floating GND or terminal GND</td> <td>Purple</td> </tr> <tr> <td>Pin N</td> <td>Input 1</td> <td>Grey/pink</td> </tr> <tr> <td>Pin O</td> <td>Input 2</td> <td>Red/blue</td> </tr> <tr> <td>Pin P</td> <td>Input 3</td> <td>White/green</td> </tr> <tr> <td>Pin R</td> <td>Input 4</td> <td>Brown/green</td> </tr> </table>			Cable			00 504 458			Black	Pin A, L	Not assigned or +12 V, max. 400 mA		Pin B	Output 1	White	Pin C	Output 2	Brown	Pin D	Output 3	Green	Pin E	Output 4	Yellow	Pin M, U *	Floating GND or terminal GND	Purple	Pin N	Input 1	Grey/pink	Pin O	Input 2	Red/blue	Pin P	Input 3	White/green	Pin R	Input 4	Brown/green
		Cable																																						
		00 504 458																																						
		Black																																						
Pin A, L	Not assigned or +12 V, max. 400 mA																																							
Pin B	Output 1	White																																						
Pin C	Output 2	Brown																																						
Pin D	Output 3	Green																																						
Pin E	Output 4	Yellow																																						
Pin M, U *	Floating GND or terminal GND	Purple																																						
Pin N	Input 1	Grey/pink																																						
Pin O	Input 2	Red/blue																																						
Pin P	Input 3	White/green																																						
Pin R	Input 4	Brown/green																																						
<p>Outputs</p>	<p>Electrically isolated via relay contacts</p> <p>Supply Limit values</p> <p>External 500 mA (max. 30 V DC) per output</p> <p>Internal 400 mA (at 12 V DC)</p> <p>Total Output 1 ... 4</p>																																							
<p>Inputs</p>	<p>Electrically isolated via optocoupler</p> <p>Supply Limit values</p> <p>External 1 mA (min. 5 V DC)</p> <p>8 mA (max. 30 V DC)</p> <p>Internal 3 mA (at 12 V DC)</p>																																							
<p>Jumper</p>	<p>Factory setting (electrically isolated)</p> 																																							

* Factory settings are indicated in bold print; switching is carried out by using the jumpers on the PCB.

WLAN	
Data transfer	WLAN IEEE 802.11b, to 11 Mbps
Frequency	2.4 GHz
Encryption	WEP 64/128 bit; WPA 128 bit, PSK, 802.1x EAP
Transmission power	Typ. 16 dBm



22013821A

Subject to technical changes © Mettler-Toledo (Albstadt) GmbH 04/06 Printed in Germany 22013821A

Mettler-Toledo (Albstadt) GmbH

D-72458 Albstadt

Tel. ++49-7431-14 0, Fax ++49-7431-14 232

Internet: <http://www.mt.com>